

Dell Networking W-AP220 Series Access Point

Installation Guide

The Dell Networking W-AP220 Series (W-AP224 and W-AP225) wireless access point (AP) supports the IEEE 802.11ac standard for high-performance WLAN. The access point uses MIMO (Multiple-in, Multiple-out) technology and other high-throughput mode techniques to deliver high-performance, 802.11n 2.4 GHz and 802.11ac 5 GHz functionality while simultaneously supporting existing legacy wireless services. The W-AP220 Series access point works only in conjunction with a Dell Networking W-Series Mobility Controller.

The W-AP220 Series access point provides the following capabilities:

- Wireless transceiver
- Protocol-independent networking functionality
- IEEE 802.11a/b/g/n/ac operation as a wireless access point
- IEEE 802.11a/b/g/n/ac operation as a wireless air monitor
- Compatibility with IEEE 802.3at PoE+ and 802.3af PoE
- Central management configuration and upgrades with a Dell Controller

Note: The W-AP220 Series requires W-Series ArubaOS 6.3.0.0 or later.

Package Contents

- W-AP224 or W-AP225 Access Point
- 9/16" and 15/16" ceiling rail adapters
- Installation guide (this document)

Note: Inform your supplier if there are any incorrect, missing, or damaged parts. If possible, retain the carton, including the original packing materials. Use these materials to repack and return the unit to the supplier if needed.

W-AP220 Series Hardware Overview

Figure 1 LEDs

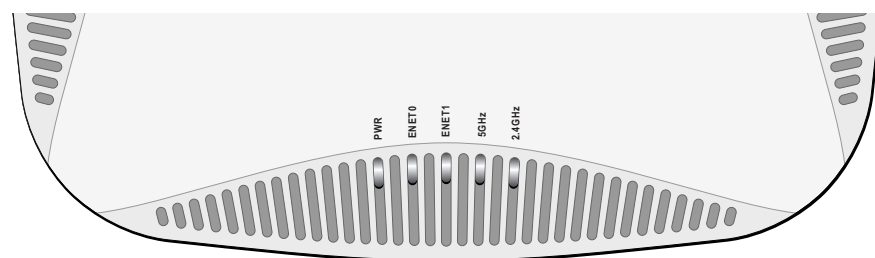

LEDs

The W-AP220 Series access point is equipped with five LEDs that indicate the status of the various components of the AP.

Table 1 LED Behavior

LED	Color/State	Meaning
PWR	Off	No power to AP
	Red	Initial power-up
	Green - Flashing	AP booting
	Green - Steady	AP ready
	Orange	AP ready and operating in PoE Power Saving Mode
ENET0, ENET1	Off	Ethernet link unavailable
	Amber - Steady	10/100Mbps Ethernet link established
	Green - Steady	1000Mbps Ethernet link established
	Flashing	Ethernet link activity
5GHz	Off	5 GHz radio disabled
	Amber - Steady	5 GHz radio enabled in non-HT WLAN mode
	Green - Steady	5 GHz radio enabled in HT WLAN mode
	Flashing - Green	5 GHz Air or Spectrum Monitor
2.4GHz	Off	2.4 GHz radio disabled
	Amber - Steady	2.4 GHz radio enabled in non-HT WLAN mode
	Green - Steady	2.4 GHz radio enabled in HT WLAN mode
	Flashing - Green	2.4 GHz Air or Spectrum Monitor

External Antenna Connectors

The W-AP224 access point is equipped with three external antenna connectors. The connectors are labeled ANT0, ANT1, and ANT2, and correspond to radio chains 0, 1, and 2.

Figure 2 External Antenna Connectors (W-AP224 only)

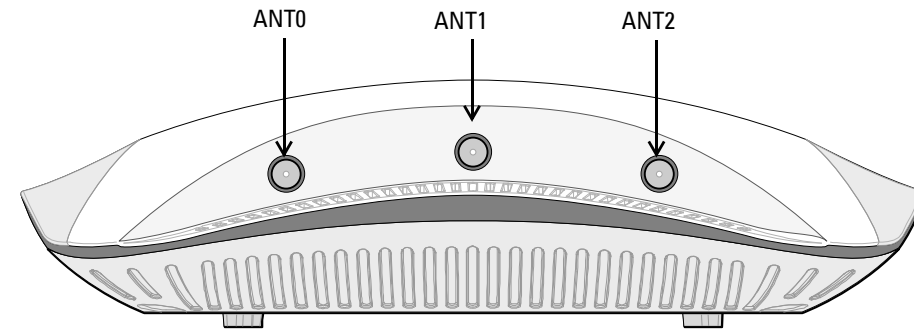
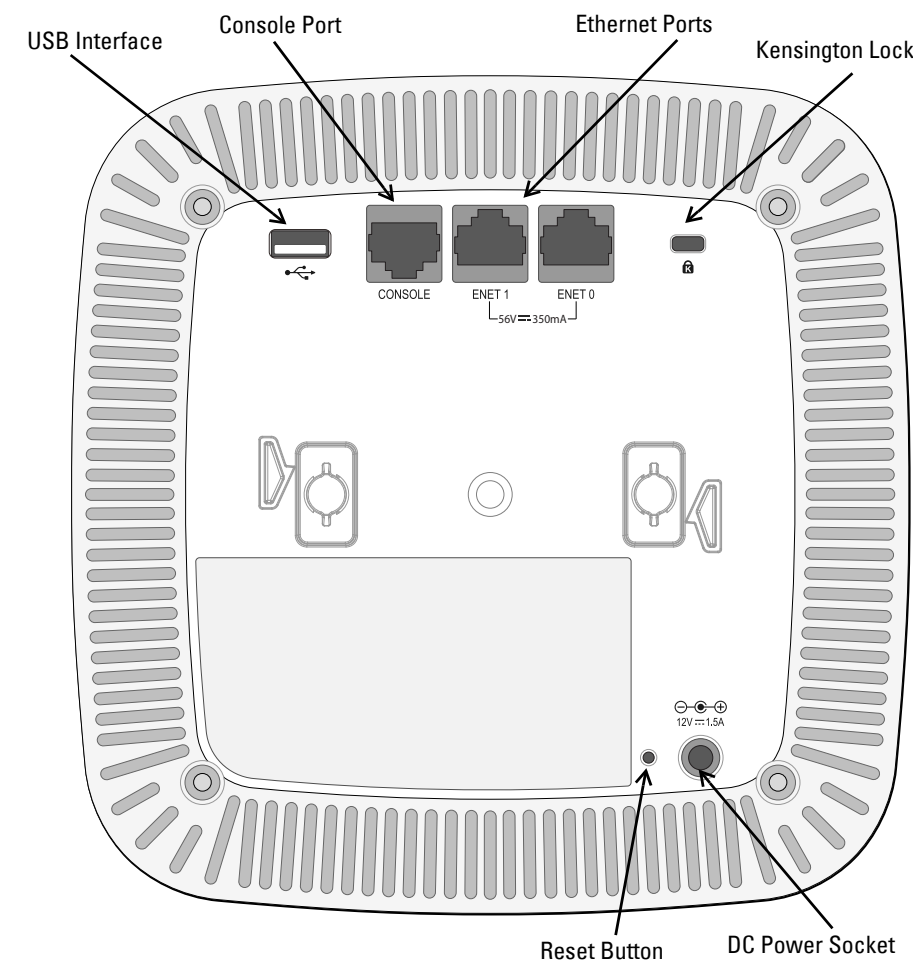

Figure 3 Bottom Panel



USB Interface

The W-AP220 Series access point is equipped with a USB interface for connectivity with cellular modems.

Note: The USB interface is disabled when the W-AP220 Series is powered from 802.3af PoE.

Console Port

The serial console port allows you to connect the W-AP220 Series access point to a serial terminal or a laptop for direct local management. This port is an RJ-45 female connector with the pinouts described in [Figure 4](#). Connect it directly to a terminal or terminal server using an Ethernet cable.

Figure 4 Serial Port Pin-Out

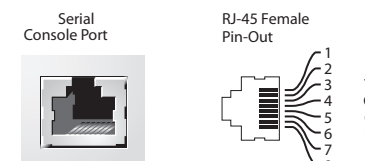

Ethernet Ports

The W-AP220 Series access point is equipped with two 10/100/1000Base-T (RJ-45) auto-sensing, MDI/MDX wired-network connectivity port. These ports support IEEE 802.3af and 802.3at Power over Ethernet (PoE) compliance, accepting 48 VDC (nominal) as a standard defined Powered Device (PD) from a Power Sourcing Equipment (PSE) such as a PoE midspan injector, or network infrastructure that supports PoE.

Note: When operating on 802.3af, only the port connected to power is usable. For example, if the power source is connected to ENET 0, then ENET 1 will not work.

The 10/100/1000 Mbps Ethernet ports are on the bottom of the AP. These ports have RJ-45 female connectors with the pin-outs shown in [Figure 5](#).

Figure 5 Gigabit Ethernet Port Pin-Out

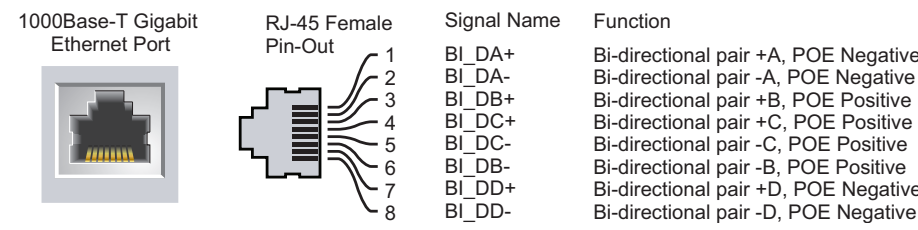

Kensington Lock Slot

The W-AP220 Series is equipped with a Kensington lock slot for additional security.

Reset Button

The reset button can be used to return the W-AP220 Series access point to factory default settings. To reset the AP:

1. Power off the AP.
2. Press and hold the reset button using a small, narrow object, such as a paperclip.
3. Power-on the AP without releasing the reset button. The power LED will flash within 5 seconds.
4. Release the reset button.

The power LED will flash again within 15 seconds indicating that the reset is completed. The AP will now continue to boot with the factory default settings.

DC Power Socket

If PoE is not available, an optional Dell AP AC-DC adapter kit (sold separately) can be used to power the W-AP220 Series. When powered in this way, the AP will operate in full power mode.

Additionally, a locally-sourced AC-to-DC adapter (or any DC source) can be used to power this device, as long as it complies with all applicable local regulatory requirements and the DC interface meets the following specifications:

- 12 VDC (+/- 5%)/18W
- Center-positive 1.7/4.0 mm circular plug, 9.5 mm length

Power Modes

The W-AP220 Series access point can operate in two power modes. The AP's mode is not configurable and is determined by the AP based on the amount of power available. The two modes are:

- Full Power: The AP is receiving power from an 802.3at PoE source or is powered using the optional AC-DC adapter kit. In this mode, all AP functionality is available.
- PoE Power Saving: The AP is receiving power from an 802.3af PoE source. In this mode, the AP has somewhat reduced functionality: the second Ethernet port is disabled, the USB port is disabled, the AP operates in 1x3 RF chain mode for 2.4 GHz (two transmit chains disabled). The behavior of 5 GHz radio depends on the ArubaOS version running on the access point:
 - 6.3.0.x: 2x3 RF chain (one transmit chain disabled)
 - 6.3.1.x or later: 3x3 RF chain (no restrictions)

Before You Begin



Caution: FCC Statement: Improper termination of access points installed in the United States configured to non-US model controllers will be in violation of the FCC grant of equipment authorization. Any such willful or intentional violation may result in a requirement by the FCC for immediate termination of operation and may be subject to forfeiture (47 CFR 1.80).



Caution: EU Statement: Lower power radio LAN product operating in 2.4 GHz and 5 GHz bands. Please refer to the *Dell Networking W-Series ArubaOS User Guide* for details on restrictions.

Produit réseau local radio basse puissance opérant dans la bande fréquence 2.4 GHz et 5 GHz. Merci de vous référer au *Dell Networking W-Series ArubaOS User Guide* pour les détails des restrictions.

Low Power FunkLAN Produkt, das im 2.4 GHz und im 5 GHz Band arbeitet. Weitere Informationen bezüglich Einschränkungen finden Sie im *Dell Networking W-Series ArubaOS User Guide*.

Apparati Radio LAN a bassa Potenza, operanti a 2.4 GHz e 5 GHz. Fare riferimento alla *Dell Networking W-Series ArubaOS User Guide* per avere informazioni dettagliate sulle restrizioni.

Pre-Installation Network Requirements

After WLAN planning is complete and the appropriate products and their placement have been determined, the Dell controller(s) must be installed and initial setup performed before the Dell APs are deployed.

For initial setup of the controller, refer to the *Dell Networking W-Series ArubaOS Quick Start Guide* for the software version installed on your controller.

AP Pre-Installation Checklist

Before installing your W-AP220 Series access point, ensure that you have the following:

- CAT5e or CAT6 UTP cable of required length
- One of the following power sources:
 - IEEE 802.3at or 802.3af-compliant Power over Ethernet (PoE) source. The POE source can be any power source equipment (PSE) controller or midspan PSE device
 - Dell AP AC-DC adapter kit (sold separately)
- Dell Controller provisioned on the network:
 - Layer 2/3 network connectivity to your access point
 - One of the following network services:
 - Aruba Discovery Protocol (ADP)
 - DNS server with an "A" record
 - DHCP Server with vendor-specific options

Summary of the Setup Process

Successful setup of an W-AP220 Series access point consists of five tasks, which must be performed in this order:

1. Verify pre-installation connectivity.
2. Identify the specific installation location for each AP.
3. Install each AP.
4. Verify post-installation connectivity.
5. Configure each AP.



Note: Dell, in compliance with governmental requirements, has designed the W-AP220 Series access points so that only authorized network administrators can change the settings. For more information about AP configuration, refer to the *Dell Networking W-Series ArubaOS Quick Start Guide* and *Dell Networking W-Series ArubaOS User Guide*.



Caution: Access points are radio transmission devices and as such are subject to governmental regulation. Network administrators responsible for the configuration and operation of access points must comply with local broadcast regulations. Specifically, access points must use channel assignments appropriate to the location in which the access point will be used.

Verifying Pre-Installation Connectivity

Before you install APs in a network environment, make sure that the APs are able to locate and connect to the controller after power on.

Specifically, you must verify the following conditions:

- When connected to the network, each AP is assigned a valid IP address
- APs are able to locate the controller

Refer to the *Dell Networking W-Series ArubaOS Quick Start Guide* for instructions on locating and connecting to the controller.

Identifying Specific Installation Locations

You can mount the W-AP220 Series access point on a wall or on the ceiling. Use the AP placement map generated by Dell VisualRF Plan software application to determine the proper installation location(s). Each location should be as close as possible to the center of the intended coverage area and should be free from obstructions or obvious sources of interference. These RF absorbers/reflectors/interference sources will impact RF propagation and should have been accounted for during the planning phase and adjusted for in RF plan.

Identifying Known RF Absorbers/Reflectors/Interference Sources

Identifying known RF absorbers, reflectors, and interference sources while in the field during the installation phase is critical. Make sure that these sources are taken into consideration when you attach an AP to its fixed location. Examples of sources that degrade RF performance include:

- Cement and brick

- Objects that contain water
- Metal
- Microwave ovens
- Wireless phones and headsets

Installing the AP



Note: Service to all Dell Networking products should be performed by trained service personnel only.

Using the Ceiling Rail Adapter

The W-AP220 Series access point ships with two ceiling rail adapters for 9/16" and 15/16" ceiling rails. Additional wall mount adapters and ceiling rail adapters for other rail styles are available as accessory kits.



Caution: Make sure the AP fits securely on the ceiling tile rail when hanging the device from the ceiling, because poor installation could cause it to fall onto people or equipment.

1. Pull the necessary cables through a prepared hole in the ceiling tile near where the AP will be placed.
2. Place the adapter against the back of the AP with the adapter at an angle of approximately 30 degrees to the tabs (see [Figure 6](#)).
3. Twist the adapter clockwise until it snaps into place in the tabs (see [Figure 6](#)).

Figure 6 Attaching the Ceiling Rail Adapter

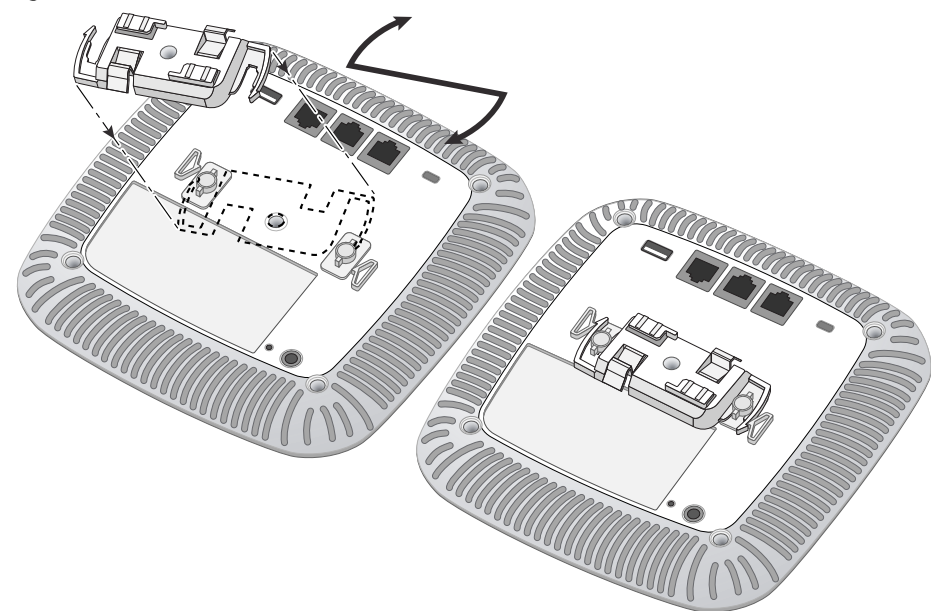

4. If necessary, connect the console cable to the console port on the back of the AP.
5. Hold the AP next to the ceiling tile rail with the ceiling tile rail mounting slots at approximately a 30-degree angle to the ceiling tile rail (see [Figure 7](#)). Make sure that any cable slack is above the ceiling tile.
6. Pushing toward the ceiling tile, rotate the AP clockwise until the device clicks into place on the ceiling tile rail.

Figure 7 Mounting the AP

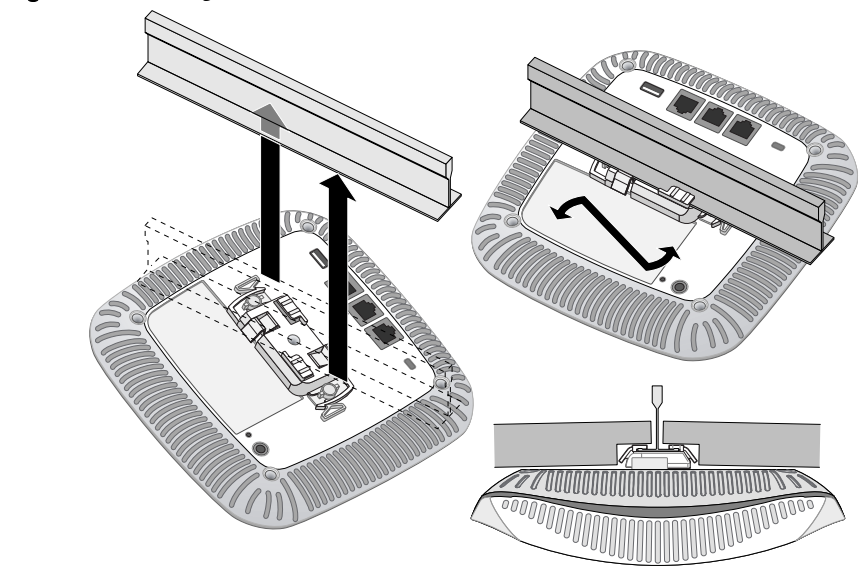

7. On the W-AP224, install the external antennas according to the manufacturer's instructions, and connect the antennas to the antenna interfaces on the AP.

Connecting Required Cables

Install cables in accordance with all applicable local and national regulations and practices.

Power Connection

The W-AP220 Series access point has a single 12V DC power jack socket to support powering through an AC-to-DC power adapter.



Note: If both POE and DC power are available, the AP draws power from the PoE source.

Verifying Post-Installation Connectivity

The integrated LEDs on the AP can be used to verify that the AP is receiving power and initializing successfully (see [Table 1](#)). Refer to the *Dell Networking W-Series ArubaOS Quick Start Guide* for further details on verifying post-installation network connectivity.

Configuring the W-AP220 Series

AP Provisioning/Reprovisioning

Provisioning parameters are unique to each AP. These local AP parameters are initially configured on the controller which are then pushed out to the AP and stored on the AP itself. Dell recommends that provisioning settings be configured via the ArubaOS Web UI only. Refer to the *Dell Networking W-Series ArubaOS User Guide* for complete details.

AP Configuration

Configuration parameters are network or controller specific and are configured and stored on the controller. Network configuration settings are pushed out to the AP(s) but remain stored on the controller.

Configuration settings can be configured via the ArubaOS Web UI or ArubaOS CLI. Refer to the *Dell Networking W-Series ArubaOS User Guide* for complete details.

Product Specifications

Electrical

- Ethernet:
 - 2 x 10/100/1000Base-T auto-sensing Ethernet RJ-45 Interfaces
 - MDI/MDX
 - IEEE 802.3 (10Base-T), IEEE 802.3u (100Base-T), IEEE 802.3ab (1000Base-T)
 - Power over Ethernet (IEEE 802.3at compliant), 48V DC (nominal) and 56V DC (maximum)/350mA (see [Figure 5](#) for pin configuration)
- Power:
 - 12 VDC power interface, supports powering through an AC-to-DC power adapter
 - POE support on Ethernet ports: 802.3at-compliant POE sourcing devices



Note: If a power adapter other than the one provided by Dell Networks is used in the US or Canada, it should be cULus (NRTL) Listed, with an output rated 12 VDC, minimum 1.25A, marked "LPS" or "Class 2," and suitable for plugging into a standard power receptacle in the US and Canada.

Environmental

- Operating:
 - Temperature: 0° C to +50° C (+32° F to +122° F)
 - Humidity: 5% to 95% non-condensing
- Storage and transportation:
 - -Temperature: -40° C to +70° C (-40° F to +158°)

For additional specifications on this product, please refer to the data sheet. The data sheet can be found at [dell.com](#).

Safety and Regulatory Compliance

Dell provides a multi-language document that contains country-specific restrictions and additional safety and regulatory information for Dell hardware products. The *Dell Networking W-Series Safety, Environmental, and Regulatory Information* document is included with the controller products.

Regulatory Model Names

The following regulatory model names apply to the W-AP220 Series access point:

- W-AP224: APIN0224
- W-AP225: APIN0225

FCC

The device is electronically labeled and the FCC ID is displayed via the WebUI under the **About** menu.



Caution: RF Radiation Exposure Statement: This equipment complies with FCC RF radiation exposure limits. This equipment should be installed and operated with a minimum distance of 7.9 inches (20 cm) between the radiator and your body for 2.4 GHz and 5 GHz operations. This transmitter must not be co-located or operating in conjunction with any other antenna or transmitter. When operated in the 5.15 to 5.25 GHz frequency range, this device is restricted to indoor use to reduce the potential for harmful interference with co-channel Mobile Satellite Systems.

FCC Class B Part 15

This device complies with Part 15 of the Federal Communications Commission (FCC) Rules. Operation is subject to the following two conditions:

- This device may not cause harmful interference.
- This device must accept any interference received, including interference that may cause undesired operation.



Caution: Changes or modifications to this unit not expressly approved by the party responsible for compliance could void the user's authority to operate this equipment.

This equipment has been tested and found to comply with the limits for a Class B digital device, pursuant to Part 15 of the FCC Rules. This equipment generates, uses and can radiate radio frequency energy and, if not installed and used in accordance with the manufacturer's instructions, may cause interference harmful to radio communications.

If this equipment does cause interference, which can be determined by turning the equipment off and on, the user is encouraged to try to correct the interference by one or more of the following measures:

- Reorient or relocate the receiving antenna.
- Increase the separation between the equipment and receiver.
- Connect the equipment to an outlet on a circuit different from that to which the receiver is connected.
- Consult the dealer or an experienced radio or TV technician for help.

Complies with the Class B limits for radio noise emissions as set out in the interference-causing equipment standard entitled "Digital Apparatus," ICES-003 of Industry Canada.

Cet appareil numérique de la classe B respecte toutes les exigences du Règlement sur le matériel brouilleur du Canada.

CE (i) EU Regulatory Conformance

Dell, hereby declares that this APIN0224 and APIN0225 device models are in compliance with the essential requirements and other relevant provisions of Directive 1999/5/EC.

CE(!)The Declaration of Conformity made under Directive 1999/5/EC is available for viewing at [dell.com](#).

Hong Kong



Singapore



UAE

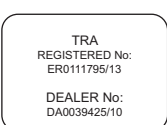
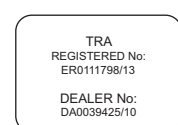

Medical

1. Equipment not suitable for use in the presence of flammable mixtures.
2. End product system, including power supply, must be evaluated to IEC 60601-1-1 and IEC 60601-1 by the end user.
3. Wipe with a dry cloth, no additional maintenance required.
4. No serviceable parts, the unit must be sent back to the manufacturer for repair.
5. No modifications are allowed without Dell approval.

Proper Disposal of Dell Equipment

Dispose of Dell products per local regulations. For the most current information about Global Environmental Compliance and Dell products, visit [dell.com](#).

Waste of Electrical and Electronic Equipment

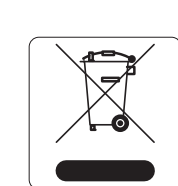

Dell products at end of life are subject to separate collection and treatment in the EU Member States, Norway, and Switzerland and therefore are marked with the symbol shown at the left (crossed-out wheeled bin). The treatment applied at end of life of these products in these countries shall comply with the applicable national laws of countries implementing Directive 2002/96/EC on Waste of Electrical and Electronic Equipment (WEEE).

China RoHS

Dell products also comply with China environmental declaration requirements and are labeled with the "EFUP 10" label shown at the left.



部件名称 (Parts)	有毒有害物质或元素 (Hazardous Substance)				
	铅 (Pb)	汞 (Hg)	镉 (Cd)	六价铬 (Cr ⁶⁺)	多溴联苯 (PBB)
电路板 (PCB Boards)	×	○	○	○	○
机械组件 (Mechanical Sub-Assemblies)	×	○	○	○	○

○: 表示该有害物质在该部件所有均质材料中的含量均在 SJ/T11363-2006 标准规定的限量要求以下。Indicates that the concentration of the hazardous substance in all homogeneous materials in the parts is below the relevant threshold of the SJ/T11363-2006 standard.

×: 表示该有害物质至少在该部件的某一均质材料中的含量超出 SJ/T11363-2006 标准规定的限量要求。Indicates that the concentration of the hazardous substance of at least one of all homogeneous materials in the parts is above the relevant threshold of the SJ/T11363-2006 standard.

对废物之回收再生产, 本表显示, 供应链的电子产品信息可能包含这些物质。This table shows where these substances may be found in the supply chain of electronic information products, as of the date of sale of the enclosed product.

此标志为针对所涉及产品的环保使用期标志。某些零部件会有一个不同的环保使用期 (例如: 电池单元模块) 标在其产品上。此环保使用期限只适用于产品是在产品手册中所规定的条件下工作。The Environment-Friendly Use Period (EFUP) for all enclosed products and their parts are per the symbol shown here. The Environment-Friendly Use Period is valid only when the product is operated under the conditions defined in the product manual.

European Union RoHS

RoHS Directive 2011/65/EC. Aruba Networks Inc., hereby, being the manufacturer of this product, declares that all CE Marked Dell wireless controller and access points products are manufactured in accordance to the provisional requirements set forth in the

A copy of the Aruba Declaration of Conformity may be obtained upon request from:

Aruba Networks International Ltd.
Building 1000,
Citygate Mahon
Cork Ireland

Please include the regulatory model number located on the product's regulatory nameplate with the request.

Dell Networking W-AP220 Series Access Point Installation Guide



Contacting Dell

Web Site Support	
Main Website	dell.com
Support Website	dell.com/support
Documentation Website	dell.com/support/manuals

Copyright

© 2013 Aruba Networks, Inc. Aruba Networks trademarks include Airwave, Aruba Networks®, Aruba Wireless Networks®, the registered Aruba the Mobile Edge Company logo, and Aruba Mobility Management System®, Dell™, the DELL™ logo, and PowerConnect™ are trademarks of Dell Inc.

All rights reserved. Specifications in this manual are subject to change without notice. Originated in the USA. All other trademarks are the property of their respective owners.

Open Source Code

Certain Aruba products include Open Source software code developed by third parties, including software code subject to the GNU General Public License (GPL), GNU Lesser General Public License (LGPL), or other Open Source Licenses. The Open Source code used can be found at this site:

http://www.arubanetworks.com/open_source

Includes software from Litech Systems Design. The IF-MAP client library copyright 2011 Infoblox, Inc. All rights reserved. This product includes software developed by Lars Fenneberg, et al.

Legal Notice

The use of Aruba Networks, Inc. switching platforms and software, by all individuals or corporations, to terminate other vendors' VPN client devices constitutes complete acceptance of liability by that individual or corporation for this action and indemnifies, in full, Aruba Networks, Inc. from any and all legal actions that might be taken against it with respect to infringement of copyright on behalf of those vendors.

[www.dell.com](#)

